

BE-6000 Series

Remote I/O Modules



Chapter 1 Product Overview

1.1 Product Introduction (RS-6000M)

RS-6000M RS485-based data acquisition and control modules provide I/O, data acquisitions, and networking in one module to build a cost effective, distributed monitoring and control solution for a wide variety of applications. With RS485-based technology, RS-6000M series modules build up a cost-effective DA&C system for building automation, environmental monitoring, and manufacturing applications. Modbus RTU/ASCII has become a standard communication protocol, and is now the most commonly available means of connecting industrial. This makes the RS-6000M series perfect for integration with HMI, SCADA, PLC and other software systems.

1.1 Product Introduction (CAN-6000T)

CAN-6000T CAN-based data acquisition and control modules provide I/O, data acquisitions, and networking in one module to build a cost effective, distributed monitoring and control solution for a wide variety of applications. With CANBus-based technology, CAN-6000T series modules build up a cost-effective DA&C system for building automation, environmental monitoring, and manufacturing applications.

1.1 Product Introduction (NET-6000M)

NET-6000M Ethernet-based data acquisition and control modules provide I/O, data acquisitions, and networking in one module to build a cost effective, distributed monitoring and control solution for a wide variety of applications. With Ethernet-based technology, NET-6000M series modules build up a cost-effective DA&C system for building automation, environmental monitoring, and manufacturing applications. Modbus TCP has become a standard communication protocol, and is now the most commonly available means of connecting industrial. This makes the NET-6000M series perfect for integration with HMI, SCADA, PLC and other software systems.

1.2 Odering Information (RS-6000M)

Model	Description
Digital I/O	
RS-6011M	RS485 Remote I/O Module with 16-ch DI
RS-6012M	RS485 Remote I/O Module with 16-ch DO
RS-6013M	RS485 Remote I/O Module with 8-ch DI and 8-ch DO
Relay Output	
RS-6014M	RS485 Remote I/O Module with 5-ch Relay (Form A)
RS-6015M	RS485 Remote I/O Module with 5-ch Relay (3-ch Form A, 2-ch Form C)
Analog Input	
RS-6021M	RS485 Remote I/O Module with 12bit 16-ch Single End AI or 8-ch differential AI
RS-6022M	RS485 Remote I/O Module with 16bit 16-ch Single End AI or 8-ch differential AI
Analog Output	
RS-6031M	RS485 Remote I/O Module with 12bit 4-ch AO
RS-6032M	RS485 Remote I/O Module with 16bit 4-ch AO
RTD	
RS-6041M	RS485 Remote I/O Module with 5-ch RTD
Thermocouple	
RS-6042M	RS485 Remote I/O Module with 5-ch TC
Mixed	
RS-6088	RS485 Remote I/O Module with 16bit 8-ch Single End AI or 4-ch differential AI, 12bit 4-ch AO, 2-ch DI, 2-ch DO

1.3 Ordering Information (CAN-6000T)

Model	Description
Digital I/O	
CAN-6011T	CAN Remote I/O Module with 16-ch DI
CAN-6012T	CAN Remote I/O Module with 16-ch DO
CAN-6013T	CAN Remote I/O Module with 8-ch DI and 8-ch DO
Relay Output	
CAN-6014T	CAN Remote I/O Module with 5-ch Relay(Form A)
CAN-6015T	CAN Remote I/O Module with 5-ch Relay(3-ch Form A, 2-ch Form C)
Analog Input	
CAN-6021T	CAN Remote I/O Module with 12bit 16-ch Single End AI or 8-ch differential AI
CAN-6022T	CAN Remote I/O Module with 16bit 16-ch Single End AI or 8-ch differential AI
Analog Output	
CAN-6031T	CAN Remote I/O Module with 12bit 4-ch AO
CAN-6032T	CAN Remote I/O Module with 16bit 4-ch AO
RTD	
CAN-6041M	CAN Remote I/O Module with 5-ch RTD
Thermocouple	
CAN-6042M	CAN Remote I/O Module with 5-ch TC
Mixed	
CAN-6088	CAN Remote I/O Module with 16bit 8-ch Single End AI or 4-ch differential AI, 12bit 4-ch AO, 2-ch DI, 2-ch DO

1.4 Ordering Information (NET-6000M)

Model	Description
Digital I/O	
NET-6011M	Ethernet Remote I/O Module with 16-ch DI
NET-6012M	Ethernet Remote I/O Module with 16-ch DO
NET-6013M	Ethernet Remote I/O Module with 8-ch DI and 8-ch DO
Relay Output	
NET-6014M	Ethernet Remote I/O Module with 5-ch Relay (Form A)
NET-6015M	Ethernet Remote I/O Module with 5-ch Relay (3-ch Form A, 2-ch Form C)
Analog Input	
NET-6021M	Ethernet Remote I/O Module with 12bit 16-ch Single End AI or 8-ch differential AI
NET-6022M	Ethernet Remote I/O Module with 16bit 16-ch Single End AI or 8-ch differential AI
Analog Output	
NET-6031M	Ethernet Remote I/O Module with 12bit 4-ch AO
NET-6032M	Ethernet Remote I/O Module with 16bit 4-ch AO
RTD	
NET-6041M	Ethernet Remote I/O Module with 5-ch RTD
Thermocouple	
NET-6042M	Ethernet Remote I/O Module with 5-ch TC
Mixed	
NET-6088	Ethernet Remote I/O Module with 16bit 8-ch Single End AI or 4-ch differential AI, 12bit 4-ch AO, 2-ch DI, 2-ch DO

Chapter 2 Hardware Information

2.1 Specifications

2.1.1 System Specifications

System			
CPU	32-bit 120MIPS CPU		
Operation System	Real-Time		
Watchdog	Yes		
Communication	RS-6000M	CAN-6000T	NET-6000M
	RS485	CAN	Ethernet 10/100 Base-TX
LED Display			
Power Indicator	Red		
Run Indicator	Green		
Error Indicator	Red		
Link Indicator	Green		
Act Indicator	Yellow		
Mechanical			
Dimensions (W x H x D)(mm)	140*110*40		
Installation	DIN-Rail mounting		
Environment			
Operating Temperature	-20°C ~ +70°C		
Storage Temperature	-30°C ~ +80°C		
Power Requirements			
Power Input	+9V ~ 30V DC		
Power Consumption	<3W		

2.1.2 I/O Specifications

2.1.2.1 NET-6011M/NET-6012M/6013M

Model	NET-6011M		NET-6012M	NET-6013M	
Digital Input					
Input Channels	16			8	
Input Type	Dry Contact	Wet Contact		Dry Contact	Wet Contact
On Voltage Level	Open to GND	0V~1V DC		Open to GND	0V~1V DC
Off Voltage Level	Close	3V~50V DC		Close	3V~50V DC
Overvoltage Protection	+70V			+70V	
Isolation	3750Vrms			3750Vrms	
Digital Output					
Output Channels			16	8	
Output Type			Sink, Open Collector(NPN)	Sink, Open Collector(NPN)	
Load Voltage			Max 50V DC	Max 50V DC	
Max Load Current			500mA/channel	500mA/channel	
Isolation			3750Vrms	3750Vrms	

2.1.2.2 NET-6014M/NET-6015M

Model	NET-6014M	NET-6015M
Relay Output		
Output Channels	5	5
Output Type	Power Relay, Form A(SPST)	Power Relay, 3-ch Form A(SPST), 2-ch Form C(SPDT)
Output Voltage	250V _{AC} /30V _{DC}	
Max Load Current	3.0A/channel	
Operate Time	6ms	
Release Time	3ms	
Electrical Life	At 30 V _{DC} / 3 A Typical 1 x 10 ⁵ operations (Operating frequency 20 operations/minute) At 250 V _{AC} / 3 A Typical 1 x 10 ⁵ operations (Operating frequency 20 operations/minute)	
Mechanical Life	2x10 ⁷	
Isolation	3750Vrms	

2.1.2.3 NET-6021M/NET6022M

Model	NET-6021M	NET-6022M
Analog Input		
Input Channels	16-ch Single End or 8-ch Differential	
Input Type	Single End or Differential	
Input Range	±10V, ±5V, ±1.25V 0-20mA(External 250ohm Resistor Needed) 4-20 mA(External 250ohm Resistor Needed)	
Input Impedance	> 10M(voltage), 250 ohm (current)	
Resolution	12-bit	16-bit
Accuracy	±0.1%	±0.01%
Sampling Rate	All channels: 16 samples/sec Per channel: 1 samples/sec	
Isolation	2500V	
Protection	Built-in TVS/ESD Protection ±4 kV Contact for each terminal	

2.1.2.4 NET-6031M/ NET-6032M

Model	NET-6031M	NET-6032M
Analog Output		
Output Channels	4	
Output Range	±10V, ±5V, 0V~5V, 0V~10V 0~20mA(Built-in 250ohm Resistor) 4~20mA(Built-in 250ohm Resistor)	
Resolution	12-bit	16-bit
Accuracy	±0.1%	±0.01%
Max Current Load Resistance	Internal power +15 V: 500 Ω. External power +24 V: 1000 Ω.	
Isolation	2500V	
Protection	Built-in TVS/ESD Protection ±4 kV Contact for each terminal	

2.1.2.5 NET-6041M

Model	NET-6041M
RTD Input	
Input Channels	5
Input Connections	2 or 3 wire
Input Type	PT100, PT200, PT500, PT1000 (-200°C~+850°C) Cu50, Cu100 (-50°C~+150°C)
Input Impedance	1.5M
ADC Resolution	24-bit
Temperature Resolution	0.1°C
Accuracy	±0.1%
Sampling Rate	All channels: 5 samples/sec Per channel: 1 samples/sec
Isolation	2500V
Protection	Built-in TVS/ESD Protection ±4 kV Contact for each terminal

2.1.2.6 NET-6042M

Model	NET-6042M	
Thermocouple Input		
Input Channels:	5	
Input Type	J	-210°C~1200°C
	K	-200°C~1370°C
	E	-100°C~1000°C
	T	-200°C~400°C
	N	-200°C~1300°C
	B	650°C~1800°C
	R	0°C~1750°C
	S	0°C~1760°C
Input Impedance:	1.5M	
ADC Resolution	24-bit	
Temperature Resolution	0.1°C	
Accuracy:	±0.1% or Better	
Sampling Rate:	All channels: 5 samples/sec Per channel: 1 samples/sec	
Isolation	2500V	
Protection	Built-in TVS/ESD Protection ±4 kV Contact for each terminal	

2.1.2.7 NET-6088M

Model	NET-6088M	
Analog Input		
Input Channels	8-ch Single End or 4-ch Differential	
Input Type	Single End or Differential	
Input Range	$\pm 10V$, $\pm 5V$, $\pm 1.25V$ 0-20mA(External 250ohm Resistor Needed) 4-20 mA(External 250ohm Resistor Needed)	
Input Impedance	> 10M(voltage), 250 ohm (current)	
Resolution	16-bit	
Accuracy	$\pm 0.01\%$	
Sampling Rate	All channels: 8 samples/sec Per channel: 1samples/sec	
Isolation	2500V	
Protection	Built-in TVS/ESD Protection ± 4 kV Contact for each terminal	
Analog Output		
Output Channels	2	
Output Range	$\pm 10V$, $\pm 5V$, 0V~5V, 0V~10V	
Resolution	12-bit	
Accuracy	$\pm 0.1\%$	
Isolation	2500V	
Protection	Built-in TVS/ESD Protection ± 4 kV Contact for each terminal	
Digital Input		
Input Channels	2	
Input Type	Dry Contact	Wet Contact
On Voltage Level	Close to GND	0V~1V DC
Off Voltage Level	Open	3V~50V DC
Overvoltage Protection	+70V	
Isolation	3750Vrms	
Digital Output		
Output Channels	2	
Output Type	Sink, Open Collector(NPN)	
Load Voltage	Max 25V DC	
Max Load Current	100mA/channel	
Isolation	3750Vrms	
Input Channels	8	

2.2 Pin Information

2.2.1 Structure

RS-6000M

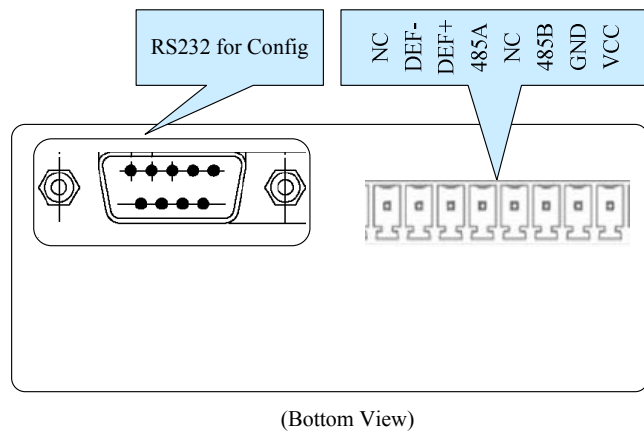
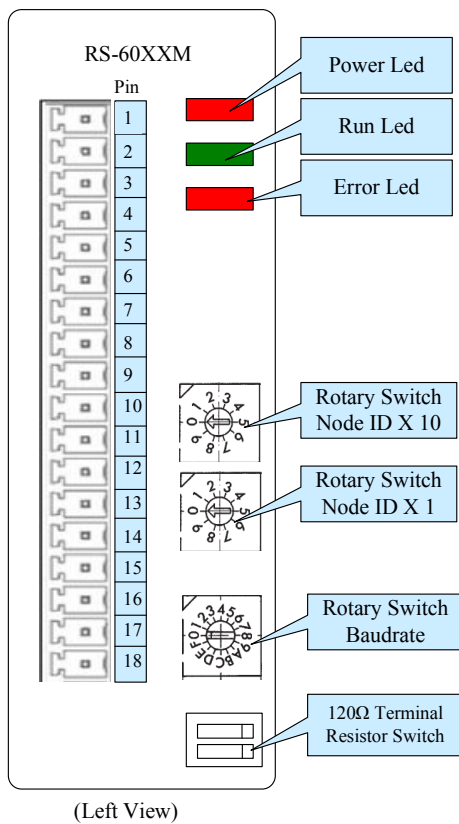

Set up baud rate by rotary button:

Rotary button code	RS485 baud rate
8-F	For software configure
7	1200bps
6	2400bps
5	4800bps
4	9600bps
3	19200bps
2	38400bps
1	57600bps
0	115200bps

CAN-6000T

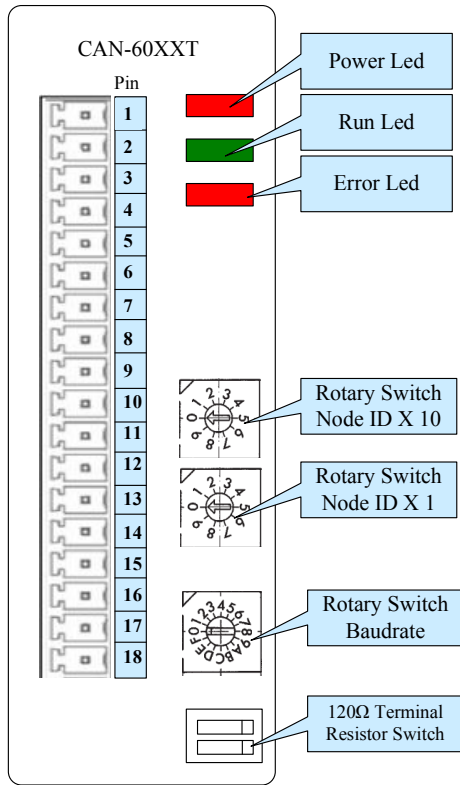

(Left View)

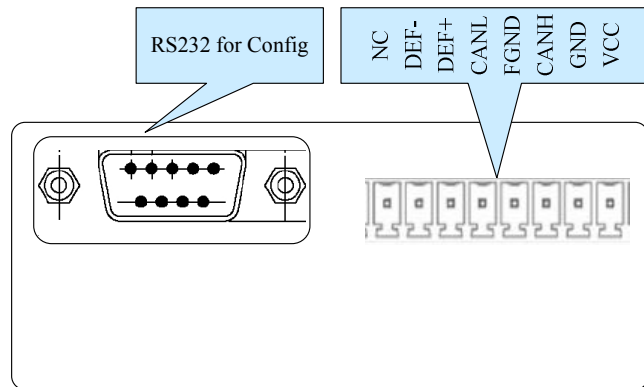

(Bottom View)

Set up the CAN baud rate by rotary button:

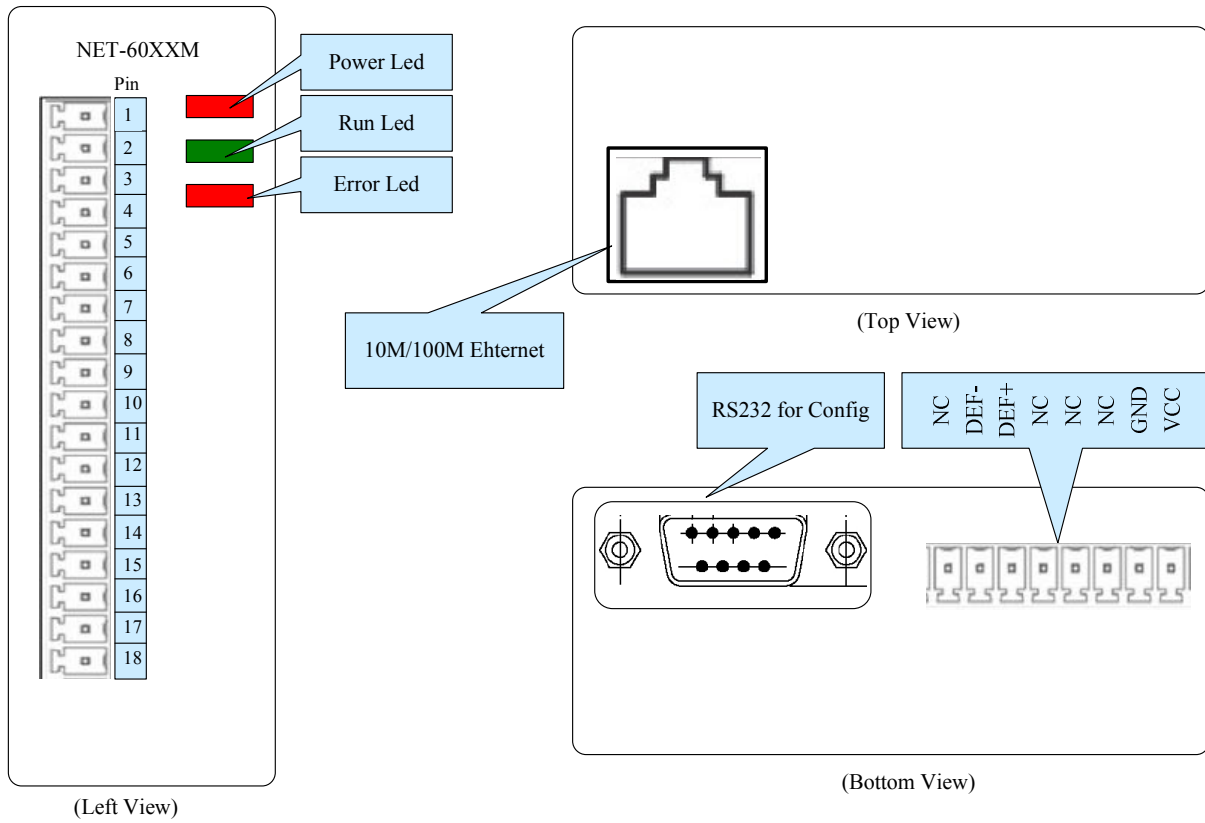

Rotary button code	CAN baud rate	BTR0(Timer 0)	BTR1(Timer 1)
F	Configure rate by software Depends on BTR0 and BTR1	Configure by software	Configure by software
E	5Kbps	0xBF	0xFF
D	10Kbps	0x31	0x1C
C	20Kbps	0x18	0x1C
B	40Kbps	0x87	0xFF
A	50Kbps	0x09	0x1C
9	80Kbps	0x83	0Xff
8	100Kbps	0x04	0x1C
7	125Kbps	0x03	0x1C
6	200Kbps	0x81	0xFA
5	250Kbps	0x01	0x1C
4	400Kbps	0x80	0xFA
3	500Kbps	0x00	0x1C
2	666Kbps	0x80	0xB6
1	800Kbps	0x00	0x16
0	1000Kbps	0x00	0x14

NET-6000M



2.2.2 Pin Assignments

2.2.2.1 NET-6011M/NET-6012M/NET-6013M

NET-6011M			NET-6012M			NET-6013M		
	Terminal No.	Pin Assignment		Terminal No.	Pin Assignment		Terminal No.	Pin Assignment
	01	DI0		01	DO0		01	DI0
	02	DI1		02	DO1		02	DI1
	03	DI2		03	DO2		03	DI2
	04	DI3		04	DO3		04	DI3
	05	DI4		05	DO4		05	DI4
	06	DI5		06	DO5		06	DI5
	07	DI6		07	DO6		07	DI6
	08	DI7		08	DO7		08	DI7
	09	DI8		09	DO8		09	DO0
	10	DI9		10	DO9		10	DO0
	11	DI10		11	DO10		11	DO2
	12	DI11		12	DO11		12	DO3
	13	DI12		13	DO12		13	DO4
	14	DI13		14	DO13		14	DO5
	15	DI14		15	DO14		15	DO6
	16	DI15		16	DO15		16	DO7
	17	Ext_GND		17	Ext_GND		17	Ext_GND
	18	NC		18	Ext_POWER		18	Ext_POWER



















2.2.2.2 NET-6014M/NET-6015M

NET-6014M			NET-6015M		
Terminal No.	Pin Assignment		Terminal No.	Pin Assignment	
01	RL0	COM	01	RL0	COM
02	RL0	NO	02	RL0	NO
03		NC	03		NC
04		NC	04		NC
05	RL1	COM	05	RL1	COM
06	RL1	NO	06	RL1	NO
07		NC	07		NC
08		NC	08		NC
09	RL2	COM	09	RL2	COM
10	RL2	NO	10	RL2	NO
11		NC	11		NC
12		NC	12	RL3	COM
13	RL3	COM	13	RL3	NC
14	RL3	NO	14	RL3	NO
15		NC	15		NC
16		NC	16	RL4	COM
17	RL4	COM	17	RL4	NC
18	RL4	NO	18	RL4	NO

2.2.2.3 NET-6021M/NET-6022M

NET-6021M/NET-6022M		
Terminal No.	Pin Assignment	
01	A10	
02	A11	
03	A12	
04	A13	
05	A14	
06	A15	
07	A16	
08	A17	
09	A18	
10	A19	
11	A110	
12	A111	
13	A112	
14	A113	
15	A114	
16	A115	
17	AGND	
18	NC	







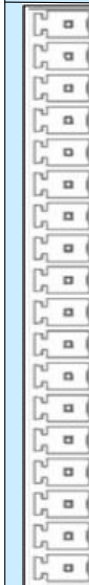
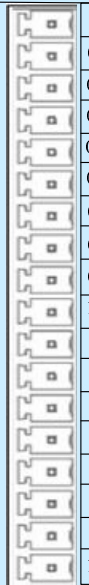











2.2.2.4 NET-6031M/NET-6032M

NET-6031M/NET-6032M	
Terminal No.	Pin Assignment
	01 VOUT0
	02 AGND
	03 IOUT0+
	04 IOUT0-
	05 VOUT1
	06 AGND
	07 IOUT1+
	08 IOUT1-
	09 VOUT2
	10 AGND
	11 IOUT2+
	12 IOUT2-
	13 VOUT3
	14 AGND
	15 IOUT3+
	16 IOUT3-
	17 NC
	18 NC

2.2.2.5 NET-6041M/NET-6042M

NET-6041M			NET-6042M		
	Terminal No.	Pin Assignment		Terminal No.	Pin Assignment
	01	RTD0+		01	TC0+
	02	RTD0-		02	TC0-
	03	COM		03	NC
	04	RTD1+		04	TC1+
	05	RTD1-		05	TC1-
	06	COM		06	NC
	07	RTD2+		07	TC2+
	08	RTD2-		08	TC2-
	09	COM		09	NC
	10	RTD3+		10	TC3+
	11	RTD3-		11	TC3-
	12	COM		12	NC
	13	RTD4+		13	TC4+
	14	RTD4-		14	TC4-
	15	COM		15	NC
	16	NC		16	NC
	17	NC		17	NC
	18	NC		18	NC

2.2.2.6 NET-6088M

NET-6088M	
Terminal No.	Pin Assignment
	A10
	A11
	A12
	A13
	A14
	A15
	A16
	A17
	AGND
	AO0
	AO1
	AGND
	DI0
	DI1
	DO0
	DO1
	DGND
	NC

2.2 Dimensions:

RS6000M CAN6000T

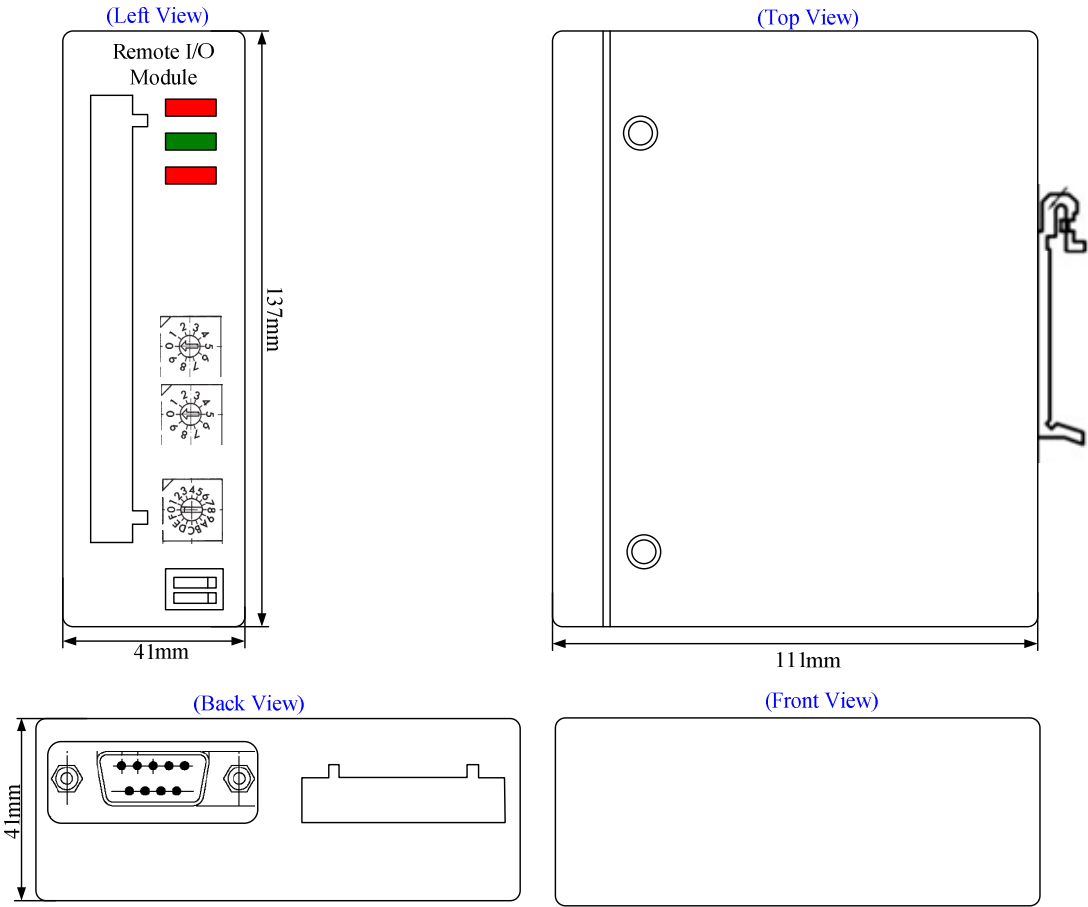

NET6000M

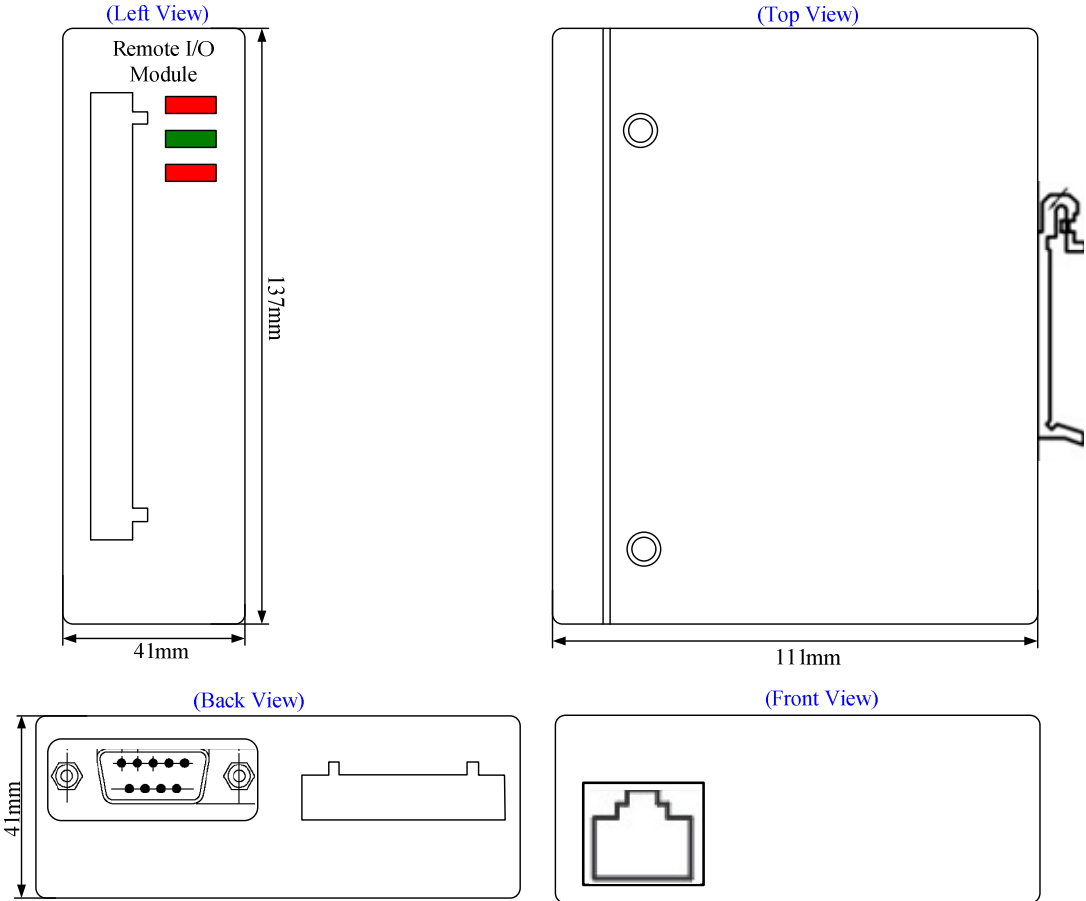

Chapter 3 Parameter Configuration

3.1 Start Page

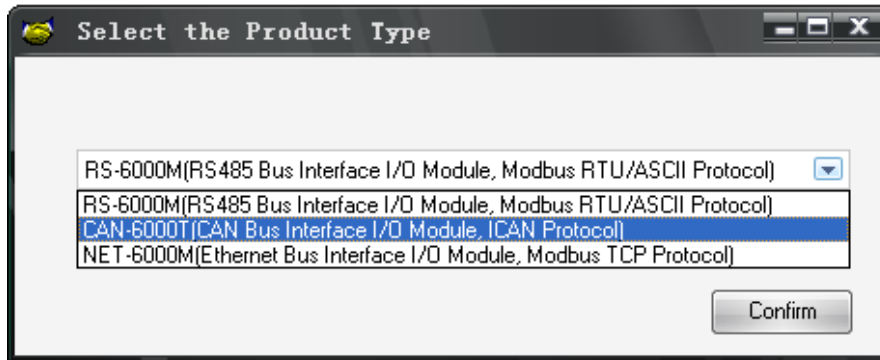

3.2 Home Page

RS-6000M

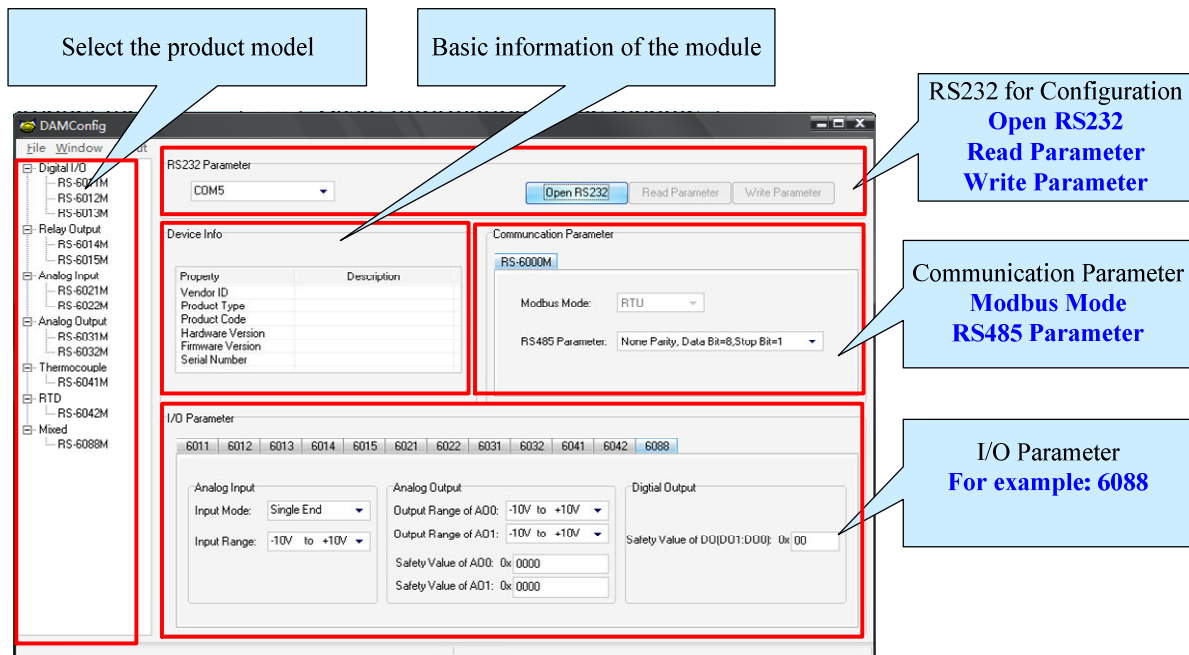

CAN6000T

Select the product model

Basic information of the module

RS232 for Configuration
Open RS232
 Read Parameter
 Write Parameter

Communication Parameter
Modbus Mode
 RS485 Parameter

I/O Parameter
 For example: 6088

NET-6000T

Select the product model

Basic information of the module

RS232 for Configuration
Open RS232
 Read Parameter
 Write Parameter

Communication Parameter
IP Address
 TCP Port

I/O Parameter
 For example: 6088

3.3 I/O Settings

3.3.1 NET-6012M/ NET-6013M/ NET-6014M/ NET-6015M

NET-6012M	 <p>Safety Value of D0(D015:D00): 0x 0000</p>
NET-6013M	 <p>Safety Value of D0(D07:D00): 0x 00</p>
NET-6014M	 <p>Safety Value of D0(D04:D00): 0x 00</p>

NET-6015M

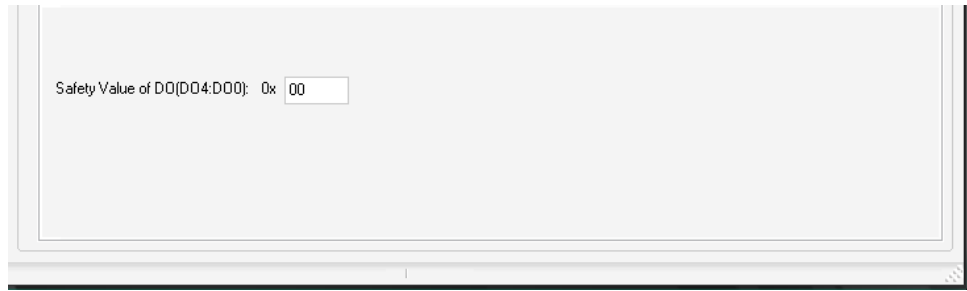

3.3.2 NET-6021M/ NET-6022M

NET-6021M
NET-6022M

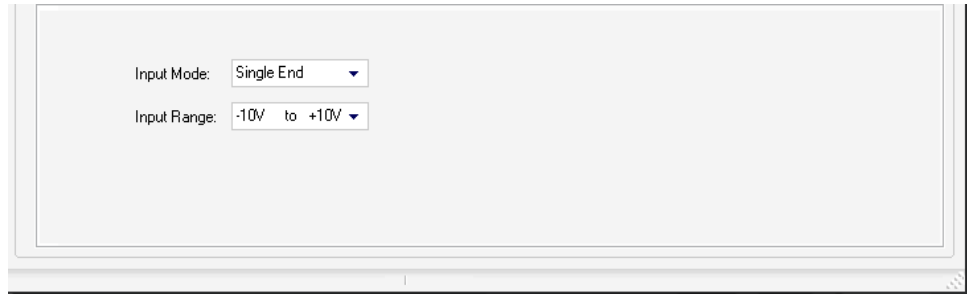

3.3.3 NET-6031M/ NET-6032M

NET-6031M
NET-6032M

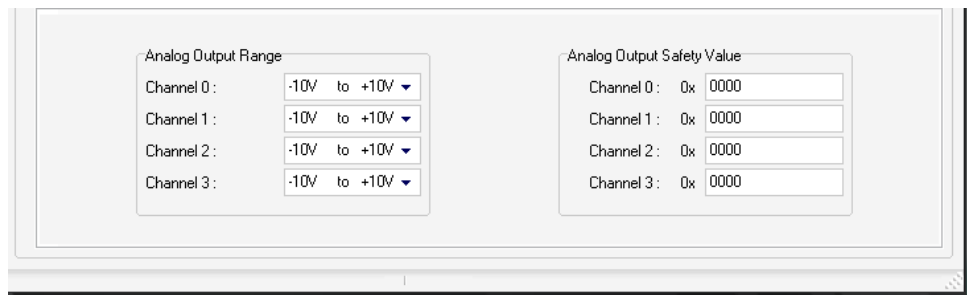

3.3.4 NET-6041M/ NET-6042M

NET-6041M

Channel 0 RTD Type: PT100
Channel 1 RTD Type: PT100
Channel 2 RTD Type: PT100
Channel 3 RTD Type: PT100
Channel 4 RTD Type: PT100

NET-6042M

Channel 0 Thermocouple Type: J
Channel 1 Thermocouple Type: J
Channel 2 Thermocouple Type: J
Channel 3 Thermocouple Type: J
Channel 4 Thermocouple Type: J

3.3.5 NET-6088M

NET-6088M

Analog Input
Input Mode: Single End
Input Range: -10V to +10V

Analog Output
Output Range of AO0: -10V to +10V
Output Range of AO1: -10V to +10V
Safety Value of AO0: 0x 0000
Safety Value of AO1: 0x 0000

Digital Output
Safety Value of DO(DO1:DO0): 0x 00

Chapter 4 Module Testing

4.1 Start Page

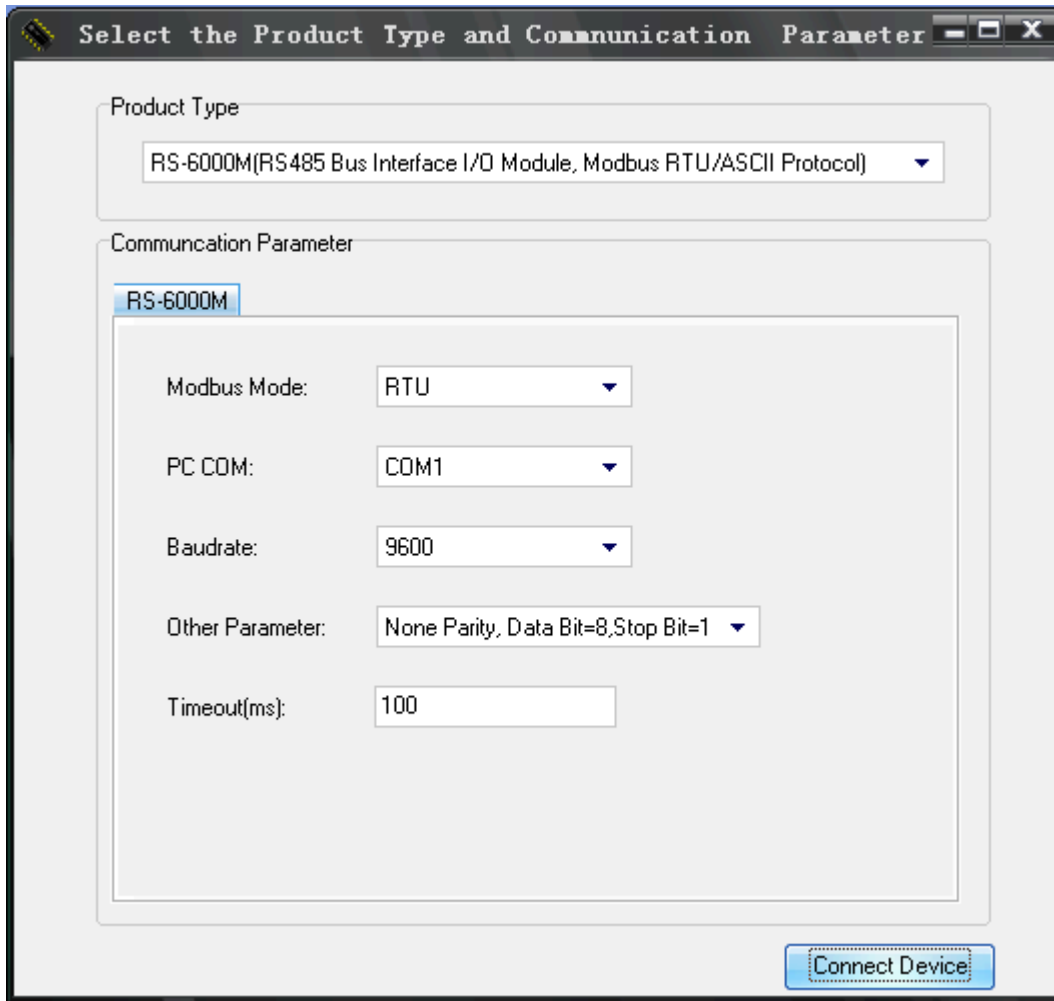

RS-6000M

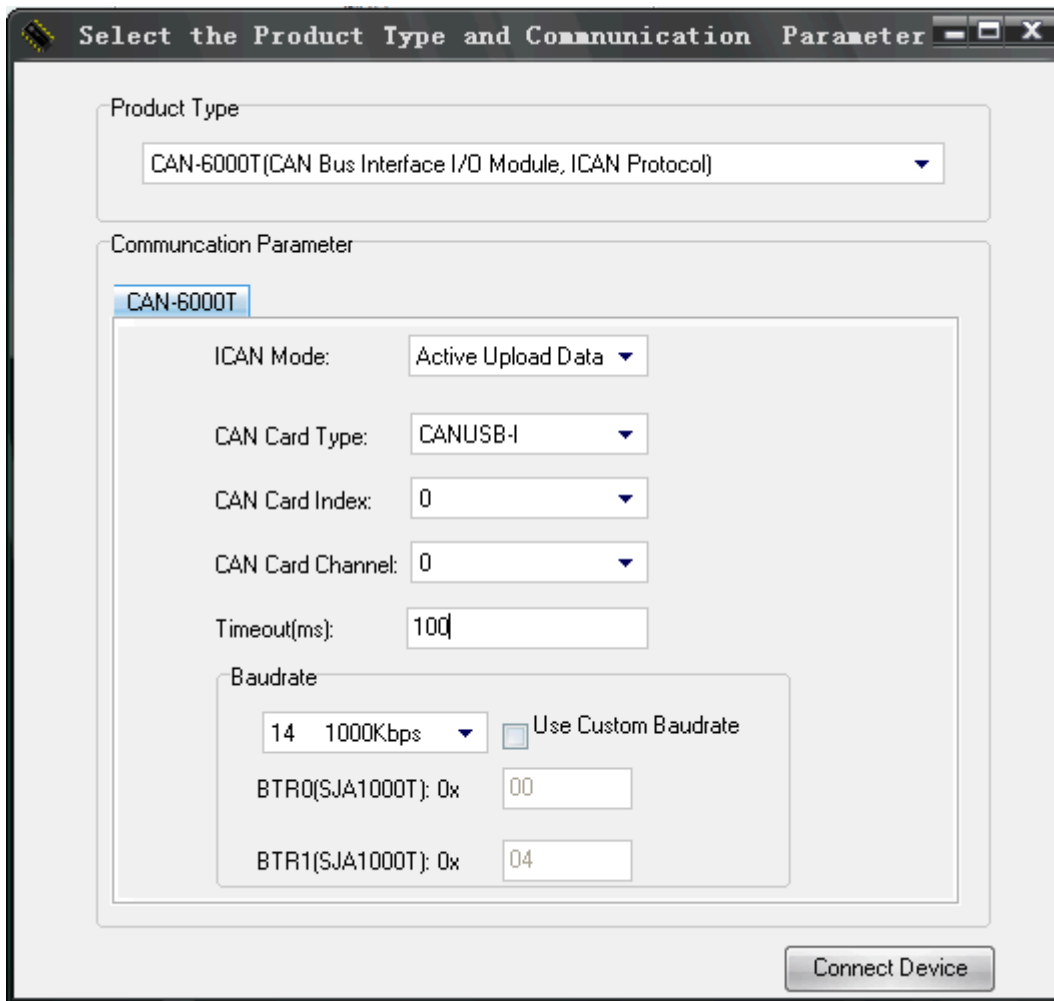

CAN-6000T

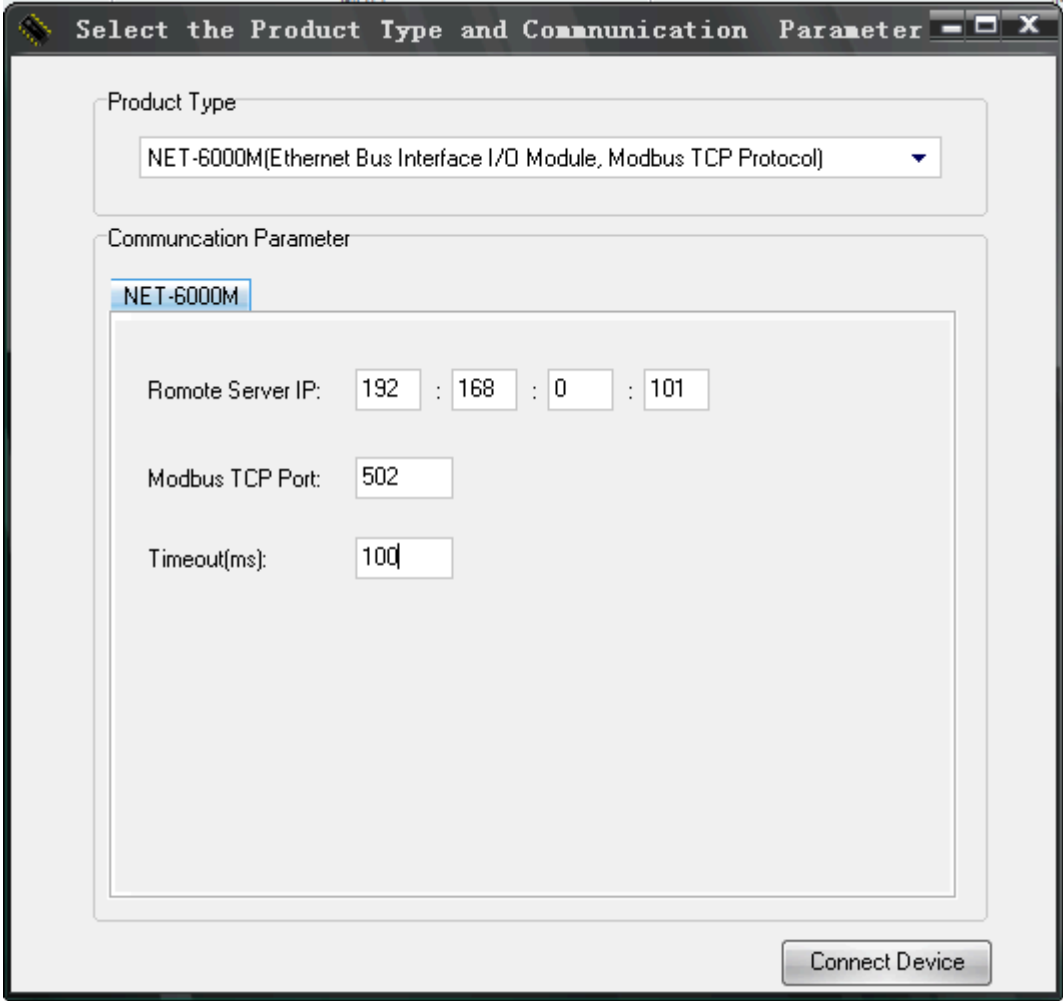

NET-6000M

4.2 I/O Testing

4.2.1 NET-6012M/ NET-6013M/ NET-6014M/ NET-6015M

NET-6011M	NET-6012M	NET-6013M
<p>Device Resources DI Channels: 16</p> <p>Digital Input <input type="checkbox"/> DI0 <input type="checkbox"/> DI1 <input type="checkbox"/> DI2 <input type="checkbox"/> DI3 <input type="checkbox"/> DI4 <input type="checkbox"/> DI5 <input type="checkbox"/> DI6 <input type="checkbox"/> DI7 <input type="checkbox"/> DI8 <input type="checkbox"/> DI9 <input type="checkbox"/> DI10 <input type="checkbox"/> DI11 <input type="checkbox"/> DI12 <input type="checkbox"/> DI13 <input type="checkbox"/> DI14 <input type="checkbox"/> DI15</p> <p>Read and Write Mode <input type="radio"/> Auto Read <input checked="" type="radio"/> Manual Read</p> <p><input type="text"/> Read Write</p>	<p>Device Resources DO Channels: 16</p> <p>Digital Input <input type="checkbox"/> DO0 <input type="checkbox"/> DO1 <input type="checkbox"/> DO2 <input type="checkbox"/> DO3 <input type="checkbox"/> DO4 <input type="checkbox"/> DO5 <input type="checkbox"/> DO6 <input type="checkbox"/> DO7 <input type="checkbox"/> DO8 <input type="checkbox"/> DO9 <input type="checkbox"/> DO10 <input type="checkbox"/> DO11 <input type="checkbox"/> DO12 <input type="checkbox"/> DO13 <input type="checkbox"/> DO14 <input type="checkbox"/> DO15</p> <p>Read and Write Mode <input type="radio"/> Auto Read <input checked="" type="radio"/> Manual Read</p> <p><input type="text"/> Read Write</p>	<p>Device Resources DI Channels: 8 DO Channels: 8</p> <p>Digital Input <input type="checkbox"/> DI0 <input type="checkbox"/> DI1 <input type="checkbox"/> DI2 <input type="checkbox"/> DI3 <input type="checkbox"/> DI4 <input type="checkbox"/> DI5 <input type="checkbox"/> DI6 <input type="checkbox"/> DI7</p> <p>Digital Output <input type="checkbox"/> DO0 <input type="checkbox"/> DO1 <input type="checkbox"/> DO2 <input type="checkbox"/> DO3 <input type="checkbox"/> DO4 <input type="checkbox"/> DO5 <input type="checkbox"/> DO6 <input type="checkbox"/> DO7</p> <p>Read and Write Mode <input type="radio"/> Auto Read <input checked="" type="radio"/> Manual Read</p> <p><input type="text"/> Read Write</p>
NET-6014M	NET-6015M	
<p>Device Resources DO Channels: 5</p> <p>Digital Input <input type="checkbox"/> DO0 <input type="checkbox"/> DO1 <input type="checkbox"/> DO2 <input type="checkbox"/> DO3 <input type="checkbox"/> DO4</p> <p>Read and Write Mode <input type="radio"/> Auto Read <input checked="" type="radio"/> Manual Read</p> <p><input type="text"/> Read Write</p>	<p>Device Resources DO Channels: 5</p> <p>Digital Input <input type="checkbox"/> DO0 <input type="checkbox"/> DO1 <input type="checkbox"/> DO2 <input type="checkbox"/> DO3 <input type="checkbox"/> DO4</p> <p>Read and Write Mode <input type="radio"/> Auto Read <input checked="" type="radio"/> Manual Read</p> <p><input type="text"/> Read Write</p>	

4.2.2 NET-6021M/ NET-6022M

NET-6021M	NET-6022M																																
<p>Device Resources AI Channels: 16 Single End or 8 Differential</p> <p>Analog Input Input Mode: <input type="text" value="Single End"/> Input Range: <input type="text" value="-10V to +10V"/></p> <table><tr><td>AI0 or (AI0 - AI1): <input type="text"/></td><td>AI1 or (AI2 - AI3): <input type="text"/></td></tr><tr><td>AI2 or (AI4 - A5): <input type="text"/></td><td>AI3 or (AI6 - AI7): <input type="text"/></td></tr><tr><td>AI4 or (AI8 - AI9): <input type="text"/></td><td>AI5 or (AI10-AI11): <input type="text"/></td></tr><tr><td>AI6 or (AI12-AI13): <input type="text"/></td><td>AI7 or (AI14-AI15): <input type="text"/></td></tr></table> <table><tr><td>AI8: <input type="text"/></td><td>AI9: <input type="text"/></td></tr><tr><td>AI10: <input type="text"/></td><td>AI11: <input type="text"/></td></tr><tr><td>AI12: <input type="text"/></td><td>AI13: <input type="text"/></td></tr><tr><td>AI14: <input type="text"/></td><td>AI15: <input type="text"/></td></tr></table> <p>Read and Write Mode <input type="radio"/> Auto Read <input checked="" type="radio"/> Manual Read</p> <p><input type="text"/></p> <p><input type="button" value="Read"/> <input type="button" value="Write"/></p>	AI0 or (AI0 - AI1): <input type="text"/>	AI1 or (AI2 - AI3): <input type="text"/>	AI2 or (AI4 - A5): <input type="text"/>	AI3 or (AI6 - AI7): <input type="text"/>	AI4 or (AI8 - AI9): <input type="text"/>	AI5 or (AI10-AI11): <input type="text"/>	AI6 or (AI12-AI13): <input type="text"/>	AI7 or (AI14-AI15): <input type="text"/>	AI8: <input type="text"/>	AI9: <input type="text"/>	AI10: <input type="text"/>	AI11: <input type="text"/>	AI12: <input type="text"/>	AI13: <input type="text"/>	AI14: <input type="text"/>	AI15: <input type="text"/>	<p>Device Resources AI Channels: 16 Single End or 8 Differential</p> <p>Analog Input Input Mode: <input type="text" value="Single End"/> Input Range: <input type="text" value="-10V to +10V"/></p> <table><tr><td>AI0 or (AI0 - AI1): <input type="text"/></td><td>AI1 or (AI2 - AI3): <input type="text"/></td></tr><tr><td>AI2 or (AI4 - A5): <input type="text"/></td><td>AI3 or (AI6 - AI7): <input type="text"/></td></tr><tr><td>AI4 or (AI8 - AI9): <input type="text"/></td><td>AI5 or (AI10-AI11): <input type="text"/></td></tr><tr><td>AI6 or (AI12-AI13): <input type="text"/></td><td>AI7 or (AI14-AI15): <input type="text"/></td></tr></table> <table><tr><td>AI8: <input type="text"/></td><td>AI9: <input type="text"/></td></tr><tr><td>AI10: <input type="text"/></td><td>AI11: <input type="text"/></td></tr><tr><td>AI12: <input type="text"/></td><td>AI13: <input type="text"/></td></tr><tr><td>AI14: <input type="text"/></td><td>AI15: <input type="text"/></td></tr></table> <p>Read and Write Mode <input type="radio"/> Auto Read <input checked="" type="radio"/> Manual Read</p> <p><input type="text"/></p> <p><input type="button" value="Read"/> <input type="button" value="Write"/></p>	AI0 or (AI0 - AI1): <input type="text"/>	AI1 or (AI2 - AI3): <input type="text"/>	AI2 or (AI4 - A5): <input type="text"/>	AI3 or (AI6 - AI7): <input type="text"/>	AI4 or (AI8 - AI9): <input type="text"/>	AI5 or (AI10-AI11): <input type="text"/>	AI6 or (AI12-AI13): <input type="text"/>	AI7 or (AI14-AI15): <input type="text"/>	AI8: <input type="text"/>	AI9: <input type="text"/>	AI10: <input type="text"/>	AI11: <input type="text"/>	AI12: <input type="text"/>	AI13: <input type="text"/>	AI14: <input type="text"/>	AI15: <input type="text"/>
AI0 or (AI0 - AI1): <input type="text"/>	AI1 or (AI2 - AI3): <input type="text"/>																																
AI2 or (AI4 - A5): <input type="text"/>	AI3 or (AI6 - AI7): <input type="text"/>																																
AI4 or (AI8 - AI9): <input type="text"/>	AI5 or (AI10-AI11): <input type="text"/>																																
AI6 or (AI12-AI13): <input type="text"/>	AI7 or (AI14-AI15): <input type="text"/>																																
AI8: <input type="text"/>	AI9: <input type="text"/>																																
AI10: <input type="text"/>	AI11: <input type="text"/>																																
AI12: <input type="text"/>	AI13: <input type="text"/>																																
AI14: <input type="text"/>	AI15: <input type="text"/>																																
AI0 or (AI0 - AI1): <input type="text"/>	AI1 or (AI2 - AI3): <input type="text"/>																																
AI2 or (AI4 - A5): <input type="text"/>	AI3 or (AI6 - AI7): <input type="text"/>																																
AI4 or (AI8 - AI9): <input type="text"/>	AI5 or (AI10-AI11): <input type="text"/>																																
AI6 or (AI12-AI13): <input type="text"/>	AI7 or (AI14-AI15): <input type="text"/>																																
AI8: <input type="text"/>	AI9: <input type="text"/>																																
AI10: <input type="text"/>	AI11: <input type="text"/>																																
AI12: <input type="text"/>	AI13: <input type="text"/>																																
AI14: <input type="text"/>	AI15: <input type="text"/>																																

4.2.2 NET-6031M/ NET-6032M

NET-6021M	NET-6022M
<p>Device Resources AD Channels: 4</p> <p>Analog Output Range of A00: -10V to +10V Range of A01: -10V to +10V</p> <p>A00: 0x 0000 A01: 0x 0000 A02: 0x 0000 A03: 0x 0000</p> <p>Read and Write Mode <input type="radio"/> Auto Read <input checked="" type="radio"/> Manual Read</p> <p><input type="text"/> <input type="button" value="Read"/> <input type="button" value="Write"/></p>	<p>Device Resources AD Channels: 4</p> <p>Analog Output Range of A00: -10V to +10V Range of A01: -10V to +10V</p> <p>A00: 0x 0000 A01: 0x 0000 A02: 0x 0000 A03: 0x 0000</p> <p>Read and Write Mode <input type="radio"/> Auto Read <input checked="" type="radio"/> Manual Read</p> <p><input type="text"/> <input type="button" value="Read"/> <input type="button" value="Write"/></p>

4.2.2 NET-6041M/ NET-6042M

NET-6041M	NET-6042M
<p>Device Resources AI Channels: 5</p> <p>Analog Input</p> <p>AI0 : <input type="text"/></p> <p>AI1 : <input type="text"/></p> <p>AI2 : <input type="text"/></p> <p>AI3 : <input type="text"/></p> <p>AI4 : <input type="text"/></p> <p>Read and Write Mode</p> <p><input type="radio"/> Auto Read <input checked="" type="radio"/> Manual Read</p> <p><input type="text"/></p> <p><input type="button" value="Read"/> <input type="button" value="Write"/></p>	<p>Device Resources AI Channels: 5</p> <p>Analog Input</p> <p>AI0 : <input type="text"/></p> <p>AI1 : <input type="text"/></p> <p>AI2 : <input type="text"/></p> <p>AI3 : <input type="text"/></p> <p>AI4 : <input type="text"/></p> <p>Read and Write Mode</p> <p><input type="radio"/> Auto Read <input checked="" type="radio"/> Manual Read</p> <p><input type="text"/></p> <p><input type="button" value="Read"/> <input type="button" value="Write"/></p>

4.3.2 NET-6088M

NET-6088M

Device Resources
AI Channels: 8 Single End or 4 Differential AO Channels: 2
DI Channels: 2 DO Channels: 2

Digital Input **Digital Output**
 DI0 DI1 DO0 DO1

Analog Input
Input Mode: Input Range:
AI0 or (AI0 - AI1): AI1 or (AI2 - AI3):
AI2 or (AI4 - A5): AI3 or (AI6 - AI7):
AI4: AI5:
AI6: AI7:

Analog Output
Range of AO0: Range of AO1:
AO0: 0x
AO1: 0x

Read and Write Mode
 Auto Read Manual Read

Chapter 5 Software Development Kit

If users intend to make a program for their own application, they need to read following descriptions very carefully, and refer the demo source code.

Develop files include BE6000.h, BE6000.lib (For VC) , BE6000bc.lib (For BC), BE6000.dll.

We provides examples for **VB**, **VB2003**, **VC**, **C++Builder**, **Delphi**, **Labview** which make it convenient for user to develop programs.

5.1 Data Structure of Library

5.1.1 RS6000M_COM_PARA

//RS6000M Commnunication Parameter

```
typedef struct _RS6000M_COM_PARA
{
    DWORD WorkMode;           //Work Mode of Modbus
    DWORD ComPort;           //COM Port
    DWORD ComBaudrate;       //COM Buadrate
    DWORD ComPara;           //COM Para
    DWORD WaitTime;
} RS6000M_COM_PARA,*P_RS6000M_COM_PARA;
```

Parameter	Description
WorkMode	RTU: 0, ASCII: 1
ComPort	COM0: 0, COM1: 1, COM2: 2
ComBaudrate	1200: 0, 2400: 1, 4800: 2
ComPara	0x00: N81; 0x01: N82; 0x02: O81; 0x03: E81
WaitTime	WaitTime of Read and Write

5.1.2 CAN6000T_COM_PARA

//CAN6000T Communication Parameter

```
typedef struct _CAN6000T_COM_PARA
{
    DWORD WorkMode;           //WorkMode of ICAN
    DWORD DevType;           //CAN Card Type
    DWORD DevIndex;          //CAN Card Index
    DWORD DevChannel;        //CAN Card Channel
    DWORD Timing0;           //BTR0 of SJA1000T
    DWORD Timing1;           //BTR1 of SJA1000T
    DWORD WaitTime;
} CAN6000T_COM_PARA,*P_CAN6000T_COM_PARA;
```

Parameter	Description
DevType	PC CAN Interface Card Type: #define CAN_Card_CANUSB_I 3 #define CAN_Card_CANUSB_II 4 #define CAN_Card_PCI5810I 2 #define CAN_Card_PCI5820I 5
WorkMode	Work Mode of the ICAN 0: Active Upload the Data 1: Passive Upload the Data
DevIndex	CAN Card Device index 0: The first device 1: The second device
DevChannel	Channel Index of the CAN Card 0: The first channel 1: The second channel
Timing0	BTR0 of SJA1000T, See Below Table.
Timing1	BTR1 of SJA1000T, See Below Table.
WaitTime	WaitTime of Read and Write

Standard Time0 and Timer1 value for SJA100T

CAN Baud rate	Timer0	Timer1
5Kbps	0xBF	0xFF
10Kbps	0x31	0x1C
20Kbps	0x18	0x1C
40Kbps	0x87	0xFF
50Kbps	0x09	0x1C
80Kbps	0x83	0Xff
100Kbps	0x04	0x1C
125Kbps	0x03	0x1C
200Kbps	0x81	0xFA
250Kbps	0x01	0x1C
400Kbps	0x80	0xFA
500Kbps	0x00	0x1C
666Kbps	0x80	0xB6
800Kbps	0x00	0x16
1000Kbps	0x00	0x14

5.1.3 NET6000M_COM_PARA

//NET6000M Communication Parameter

```
typedef struct _NET6000M_COM_PARA
{
    BYTE DevIP[4];      //IP Address of Server
    DWORD DevPort;     //IP Port of Server
    DWORD WaitTime;
} NET6000M_COM_PARA,*P_NET6000M_COM_PARA;
```

Parameter	Description
DevIP[4]	IP Address of the Module
DevPort	TCP Port of the Module
WaitTime	Wait Time of Read and Write

5.2 API description

[1] [Connect the Module](#)

HANDLE __stdcall BE6000_ConnectDevice(DWORD ModuleType, void *ModuleComPara);

Parameter	Description
ModuleType	Module Type 0x00: RS6000M 0x01: CAN6000I 0x04: NET6000M
ModuleComPara	Communication Parameter Structure(See 5.1) RS6000M_COM_PARA: RS6000M Series CAN6000I_COM_PARA: CAN6000I Series NET6000M_COM_PARA: NET6000M Series
Return value	!NULL: Success Others: Fail

[2] [Disconnect the Module](#)

BOOL __stdcall BE6000_DisconnectDevice (HANDLE ModuleHandle);

Parameter	Description
ModuleHandle	Module Handle Get by the Function of BE6000_ConnectDevice
Return value	1: Success 0: Fail

[3] [Read the Analog Input](#)

BOOL __stdcall BE6000_ReadDeviceAD(HANDLE ModuleHandle, DWORD ModuleID, WORD * ADValue, DWORD FirstChannel, DWORD ChannelCount)

Parameter	Description
ModuleHandle	Module Handle Get by the Function of BE6000_ConnectDevice
ModuleID	Module ID
ADValue	Pointer of the Buffer
FirstChannel	Start Channel
ChannelCount	Channel Count
Return value	1: Success 0: Fail

[4] [Read the Analog Output](#)

BOOL __stdcall BE6000_ReadDeviceDA (HANDLE ModuleHandle, DWORD ModuleID, WORD * DAValue, DWORD FirstChannel, DWORD ChannelCount)

Parameter	Description
ModuleHandle	Module Handle Get by the Function of BE6000_ConnectDevice
ModuleID	Module ID
DAValue	Pointer of the Buffer
FirstChannel	Start Channel
ChannelCount	Channel Count
Return value	1: Success 0: Fail

[5] Write the Analog Output

BOOL __stdcall BE6000_WriteDeviceDA(HANDLE ModuleHandle, DWORD ModuleID, WORD * DAValue, DWORD FirstChannel, DWORD ChannelCount)

Parameter	Description
ModuleHandle	Module Handle Get by the Function of BE6000_ConnectDevice
ModuleID	Module ID
DAValue	Pointer of the Buffer
FirstChannel	Start Channel
ChannelCount	Channel Count
Return value	1: Success 0: Fail

[6] Read the Digital Input

BOOL __stdcall BE6000_GetDeviceDI(HANDLE ModuleHandle, DWORD ModuleID, BYTE * IOValue, DWORD FirstChannel, DWORD ChannelCount);

Parameter	Description
ModuleHandle	Module Handle Get by the Function of BE6000_ConnectDevice
ModuleID	Module ID
IOValue	Pointer of the Buffer
FirstChannel	Start Channel
ChannelCount	Channel Count
Return value	1: Success 0: Fail

[7] [Read the Digital Output](#)

```
BOOL __stdcall BE6000_GetDeviceDO(HANDLE ModuleHandle, DWORD ModuleID, BYTE *
IOValue, DWORD FirstChannel, DWORD ChannelCount);
```

Parameter	Description
ModuleHandle	Module Handle Get by the Function of BE6000_ConnectDevice
ModuleID	Module ID
IOValue	Pointer of the Buffer
FirstChannel	Start Channel
ChannelCount	Channel Count
Return value	1: Success 0: Fail

[8] [Write the Digital Output](#)

```
BOOL __stdcall BE6000_SetDeviceDO(HANDLE ModuleHandle, DWORD ModuleID, BYTE *
IOValue, DWORD FirstChannel, DWORD ChannelCount);
```

Parameter	Description
ModuleHandle	Module Handle Get by the Function of BE6000_ConnectDevice
ModuleID	Module ID
IOValue	Pointer of the Buffer
FirstChannel	Start Channel
ChannelCount	Channel Count
Return value	1: Success 0: Fail

5.3 Interface library function using flow

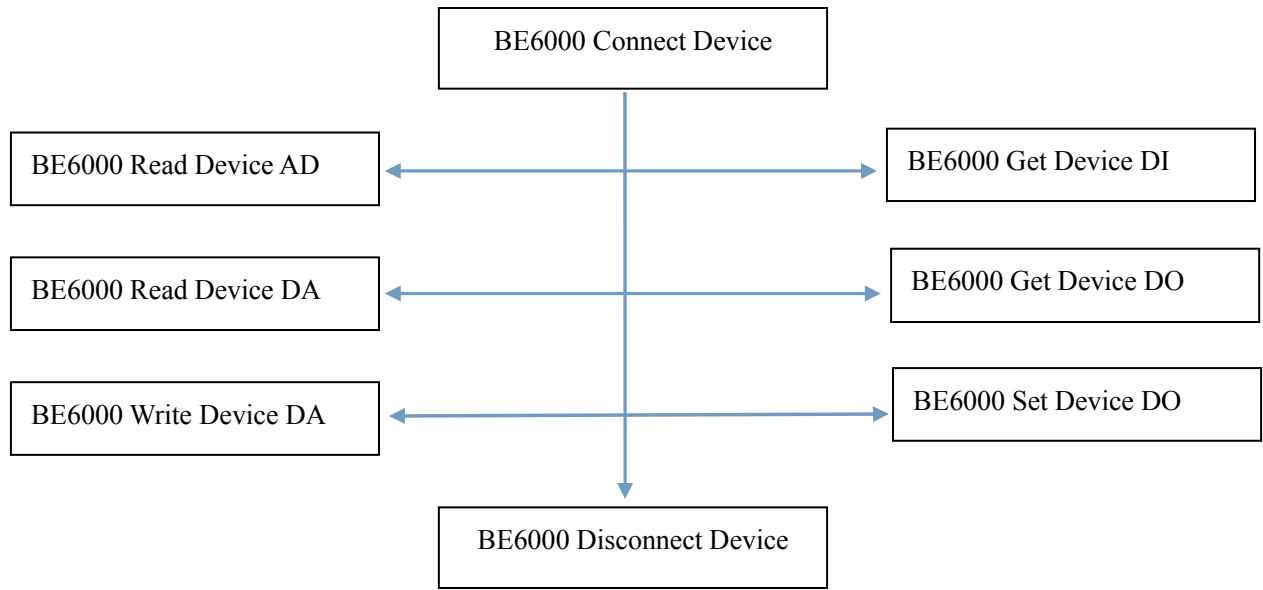

Calling flow of the BE6000 interface function

Appendix A: BE-6000 I/O Modbus Address Mapping Table

Function Code

Code	Function
01(0x01)	Read the Status of the Coils (Read DOs)
02(0x02)	Read the Status of the Inputs(Read DIs)
03(0x03)	Read the Holding Registers(Read AOs)
04(0x04)	Read the Input Registers(Read AIs)
05(0x05)	Force a Single Coil(Write DO)
06(0x06)	Preset a Single Register(Write AO)
15(0x0F)	Force Multiple Coils(Write DOs)
16(0x10)	Preset Multiple Registers(Write AOs)

NET-6012M/ NET-6013M/ NET-6014M/ NET-6015M

Model	Address	Data Type	Description	Access Type
NET-6011M	0x0000-0x000F	1 Bit	DI0-DI15,DI Value 0=OFF, 1=ON Function Code(0x02)	R
NET-6012M	0x0020-0x002F	1 Bit	DO0-DO15, DO Value 0=OFF, 1=ON Function Code(0x01,0x05,0x0F)	R/W
NET-6013M	0x0000-0x0007	1 Bit	DI0-DI7,DI Value 0=OFF, 1=ON Function Code(0x02)	R
	0x0020-0x0027	1 Bit	DO0-DO7, DO Value 0=OFF, 1=ON Function Code(0x01,0x05,0x0F)	R/W
NET-6014M NET-6015M	0x0020-0x0024	1 Bit	DO0-DO4, DO Value 0=OFF, 1=ON Function Code(0x01,0x05,0x0F)	R/W

NET-6021M/ NET-6022M

Model	Address	Data Type	Description	Access Type
NET-6021M	0x0040-0x004F	1 Word	AI0-AI15, AI Value Function Code(0x04)	R
NET-6022M	0x0040-0x004F	1 Word	AI0-AI15, AI Value Function Code(0x04)	R

NET-6031M/ NET-6032M

Model	Address	Data Type	Description	Access Type
NET-6031M	0x0060-0x0063	1 Word	AO0-AO3, AO Value Function Code(0x03,0x06,0x10)	R/W
NET-6032M	0x0060-0x0063	1 Word	AO0-AO3, AO Value Function Code(0x03,0x06,0x10)	R/W

NET-6041M/ NET-6042M

Model	Address	Data Type	Description	Access Type
NET-6041M	0x0040-0x0044	1 Word	AI0-AI4, AI Value(RTD) Function Code(0x04)	R
NET-6042M	0x0040-0x0044	1 Word	AI0-AI4, AI Value(TC) Function Code(0x04)	R

NET-6088M

Model	Address	Data Type	Description	Access Type
NET-6088M	0x0040-0x0047	1 Word	AI0-AI7, AI Value Function Code(0x04)	R
	0x0060-0x0061	1 Word	AO0-AO1, AO Value Function Code(0x03,0x06,0x10)	R/W
	0x0000-0x0001	1 Bit	DI0-DI1, DI Value 0=OFF, 1=ON Function Code(0x02)	R
	0x0020-0x0021	1 Bit	DO0-DO1, DO Value 0=OFF, 1=ON Function Code(0x01,0x05,0x0F)	R/W

Appendix B: Data Formats and I/O Ranges

6021/ 6022

Model	Input Range	Data Formats	-Full Scale	+Full Scale
6021	±10 V ±5 V ±2.5 V ±1.25 V	Straight Binary	0x0000	0x0FFF
6022	±10 V ±5 V ±2.5 V ±1.25 V	Straight Binary	0x0000	0xFFFF

6031/ 6032

Model	Output Range	Data Formats	-Full Scale	+Full Scale
6031	±10 V ±5 V 0 V-10V 0V-5V (0-20mA, $I=V/250$)	Straight Binary	0x0000	0x0FFF
6032	±10 V ±5 V 0 V-10V 0V-5V (0-20mA, $I=V/250$)	Straight Binary	0x0000	0xFFFF

6041/ 6042

Model	Input Range	Data Formats	
6041	PT100, PT200, PT500, PT1000 (-200°C ~ +850°C)	Bit15=0, Bit15=1,	
	Cu50, Cu100 (-50°C ~ +150°C)		
6042	J		-210°C~1200°C
	K		-200°C~1370°C
	E		-100°C~1000°C
	T		-200°C~400°C
	N		-200°C~1300°C
	B		650°C~1800°C
	R		0°C~1750°C
	S		0°C~1760°C

6088

Model	Input Range	Data Formats	-Full Scale	+Full Scale
6088	±10 V ±5 V ±2.5 V ±1.25 V	Straight Binary	0x0000	0x0FFF

All rights reserved by **Bueno Electric**

Contact: sales@bueno-electric.com